

NIVOTRACK

M-500/600, M-500/600 Ex

two-wire magnetostrictive level transmitters

User's and Programming manual
8th edition



Manufacturer:
NIVELCO Process Control Co.
H-1043 Budapest, Dugonics u. 11.
Tel.: (36-1) 889-0100 ■ Fax: (36-1) 889-0200
E-mail: sales@nivelco.com ■ www.nivelco.com



BASIC CONCEPT OF MEASUREMENT WITH NIVOTRACK

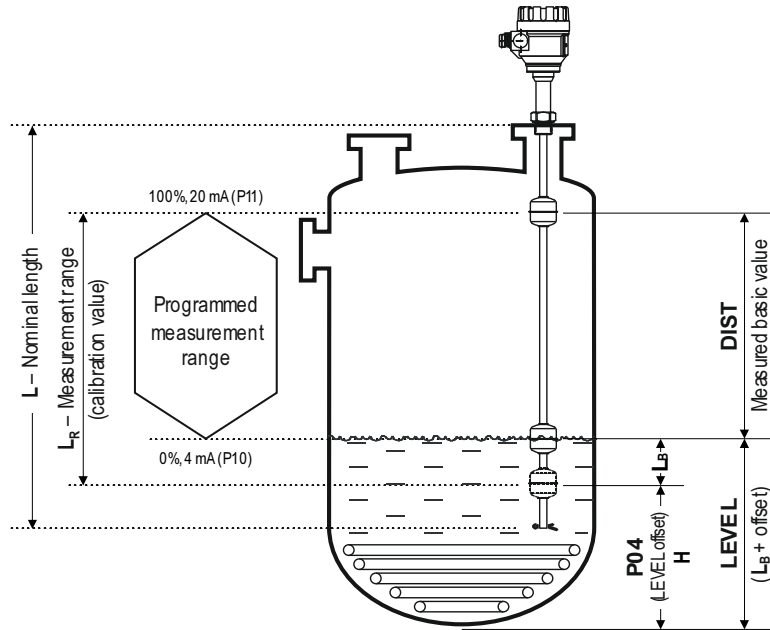

$$\text{LEVEL} = \text{L} - \text{DIST} + \text{P04}$$

TABLE OF CONTENTS

1. INTRODUCTION	5	5.3.2.3 <i>Output current value 20mA</i>	25
2. ORDER CODE	6	5.3.2.4 <i>Output current error mode</i>	26
2.1. DIMENSIONS	8	5.3.2.5 <i>Fixed output current</i>	26
3. TECHNICAL DATA	10	5.3.3. <i>Digital Output</i>	26
3.1. MEASUREMENT DATA (MSZ EN 60770-1:2011, MSZ EN 61298-1:2009, MSZ EN 61298-3:2009):	11	5.3.3.1 <i>HART polling address (if there is a HART option in the device)</i>	26
3.2. SPECIAL DATA FOR EX CERTIFIED MODELS	12	5.3.4. <i>Calculations</i>	26
3.3. ACCESSORIES	13	5.3.4.1 <i>Zero point offset (Distance between the lowest position of the float and the bottom of the tank)</i>	26
3.4. SPECIAL CONDITIONS FOR SAFE USE	13	5.3.4.2 <i>Calculation mode</i>	27
3.5. TEMPERATURE CLASSES AND TEMPERATURE LIMITS	14	5.3.4.3 <i>Tank function / shape</i>	27
3.6. MAINTENANCE AND REPAIR	14	5.3.4.4 <i>Tank bottom shape</i>	28
4. INSTALLATION	15	5.3.4.5 <i>Tank dimensions</i>	29
4.1. MOUNTING	15	5.3.4.6 <i>Volume and Mass Table (VMT)</i>	30
4.2. WIRING	16	5.3.5. <i>Service functions</i>	31
4.2.1. <i>Wiring of Ex certified units</i>	17	5.3.5.1 <i>Security codes</i>	31
4.3. LOOP CURRENT CHECKING	17	5.3.5.2 <i>Current output test</i>	31
5. PROGRAMMING	18	5.3.5.3 <i>Distance simulation</i>	32
5.1. THE SAP-300 DISPLAY UNIT	19	5.3.5.4 <i>Load default values</i>	33
5.1.1. <i>THE SAP-300 MODULE</i>	19	5.3.5.5 <i>Service distance offset</i>	33
5.2. PROGRAMMING WITH THE SAP-300 DISPLAY UNIT	21	5.3.5.6 <i>Restart</i>	33
5.2.1. <i>Elements of the programming interface</i>	21	6. ERROR CODES	34
5.2.2. <i>Menu structure</i>	22	7. MENU MAP	35
5.3. PROGRAMMABLE FEATURES DESCRIPTION	23		
5.3.1. <i>Basic measurement settings</i>	23		
5.3.1.1 <i>Units</i>	23		
5.3.1.2 <i>PV mode</i>	23		
5.3.1.3 <i>Damping time</i>	24		
5.3.1.4 <i>Application</i>	24		
5.3.1.5 <i>Installation mode (ONLY USD (UpSide Down) – „Reverse installation position“ devices)</i>	24		
5.3.2. <i>Analogue Output</i>	25		
5.3.2.1 <i>Output current mode</i>	25		
5.3.2.2 <i>Output current value 4mA</i>	25		



*Thank you for choosing a NIVELCO instrument.
We are sure that you will be satisfied throughout its use!*

1. INTRODUCTION

Application

NIVOTRACK M-500 series working on the magnetostrictive principle are suitable for high accuracy level measurement of storage tanks. Due to their high temperature and pressure rating these units can also be used for level gauging of technological tanks. The most suitable applications are with liquids free of solid particles and with low viscosity both in ordinary and hazardous locations.

Its high precision renders NIVOTRACK suitable for custody transfer measurement of valuable liquids such as fuels, solvents, alcohol distillates, etc. Plastic version of the series substantially expands the field of application by a wide range of aggressive materials.

Operating principle

The magnetostrictive transmitter is using the special feature of the magnetostrictive wire spanned in the rigid or flexible probe. A magnetic field excited in the magnetostictive wire develops a wave in the wire. From the interference point with the magnetic disc placed in the float the wave travels back to the electronics with defined velocity. Measurement is based on measuring the flying time since it is proportional with the distance of the float from the electronics.

The above distance constitutes the basis for all output signals of the NIVOTRACK!

With the help of further mechanical data level and volume (tank content) can be calculated.

2. ORDER CODE

NIVOTRACK M - -

TYPE	CODE
Transmitter	T
Transmitter+display	B
Transmitter PFA coated probe	E
Transmitter+display PFA coated probe	G
Transmitter mini	M
Transmitter mini + display	C

PROBE / PROCESS CONNECTION	CODE
Tube 1" BSP	A
Tube 2" BSP	C
Tube 1" NPT	D
Tube 2" NPT	G
Tube, w/o process conn	U*
Flexible 2" BSP	K
Flexible 2" NPT	N
Flexible, w/o proc. conn.	Z
Rigid tube for NIVOFLIP, with clamp, without float	L

HOUSING	CODE
Aluminium	5
Plastic	6
Stainless steel	7

CODE	NOMINAL LENGTH		CODE
0	0 m	0 m	0
1	1 m	0.1 m	1
2	2 m	0.2 m	2
3	3 m	0.3 m	3
4	4 m	0.4 m	4
5	5 m	0.5 m	5
6	6 m	0.6 m	6
7	7 m	0.7 m	7
8	8 m	0.8 m	8
9	9 m	0.9 m	9
A	10 m		
B	11 m		
C	12 m		
D	13 m		
E	14 m		
F	15 m		

OUTPUT / RESOLUTION / Ex	CODE
4 ... 20 mA / 0.1 mm	1
4 ... 20 mA / 1 mm	2
4 ... 20 mA + HART / 0.1 mm	3
4 ... 20 mA + HART / 1 mm	4
4 ... 20 mA / 0.1 mm / Ex ia	5
4 ... 20 mA / 1 mm / Ex ia	6
4 ... 20 mA + HART / 0.1 mm / Ex ia	7
4 ... 20 mA + HART / 1 mm / Ex ia	8
4 ... 20 mA / 0.1 mm / Ex ia / IP68	9
4 ... 20 mA / 0.1 mm / Ex d	A
4 ... 20 mA + HART / 0.1 mm / Ex d	B
4 ... 20 mA / 0.1 mm / Ex ia + Ex d	C
4 ... 20 mA + HART / 0.1 mm / Ex ia + Ex d	D
4 ... 20 mA / 0.1 mm / XP dual compartment	E
4 ... 20 mA + HART / 0.1 mm / XP dual comp.	F

* Process connection to be ordered separately
(NOT ALL COMBINATIONS AVAILABLE!)

For certified level measurement for custody transfer only the HART output with 0.1 mm resolution version including local display unit can be ordered.

ACCESSORIES TO BE ORDERED:

FLANGES: M F T - -

STANDARDS/MATERIAL	CODE	DIMENSION DIN ANSI	CODE	PRESSURE	CODE	INNER DESIGN	CODE
DIN / carbon steel	1	DN 65 2½"	1	PN 16 / 150 psi	1	1" BSP	2
DIN / 1.4571	2	DN 80 3"	2	PN 25 / 300 psi	2	2" BSP	3
DIN / PP	3	DN 100 4"	3			1" NPT	5
DIN / carbon steel + PTFE	4	DN 125 5"	4			2" NPT	6
ANSI / carbon steel	5	DN 150 6"	5			Sliding sleeve	A
ANSI / 1.4571	6	DN 200 8"	6				
ANSI / PP	7						
ANSI / carbon steel+PTFE	8						

SLIDING SLEEVES:

TYPE	CONNECTION	S (mm)	H (mm)	L (mm)	B (mm)
MBH-105-2M-300-00	1" BSP	41	36	20	
MBK-105-2M-300-00	2" BSP	60	55	24	
MBL-105-2M-300-00	1" NPT	41	38		~10
MBN-105-2M-300-00	2" NPT	60	44.5		~11

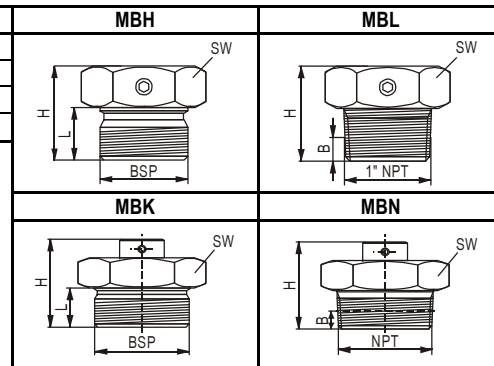

2.1. DIMENSIONS

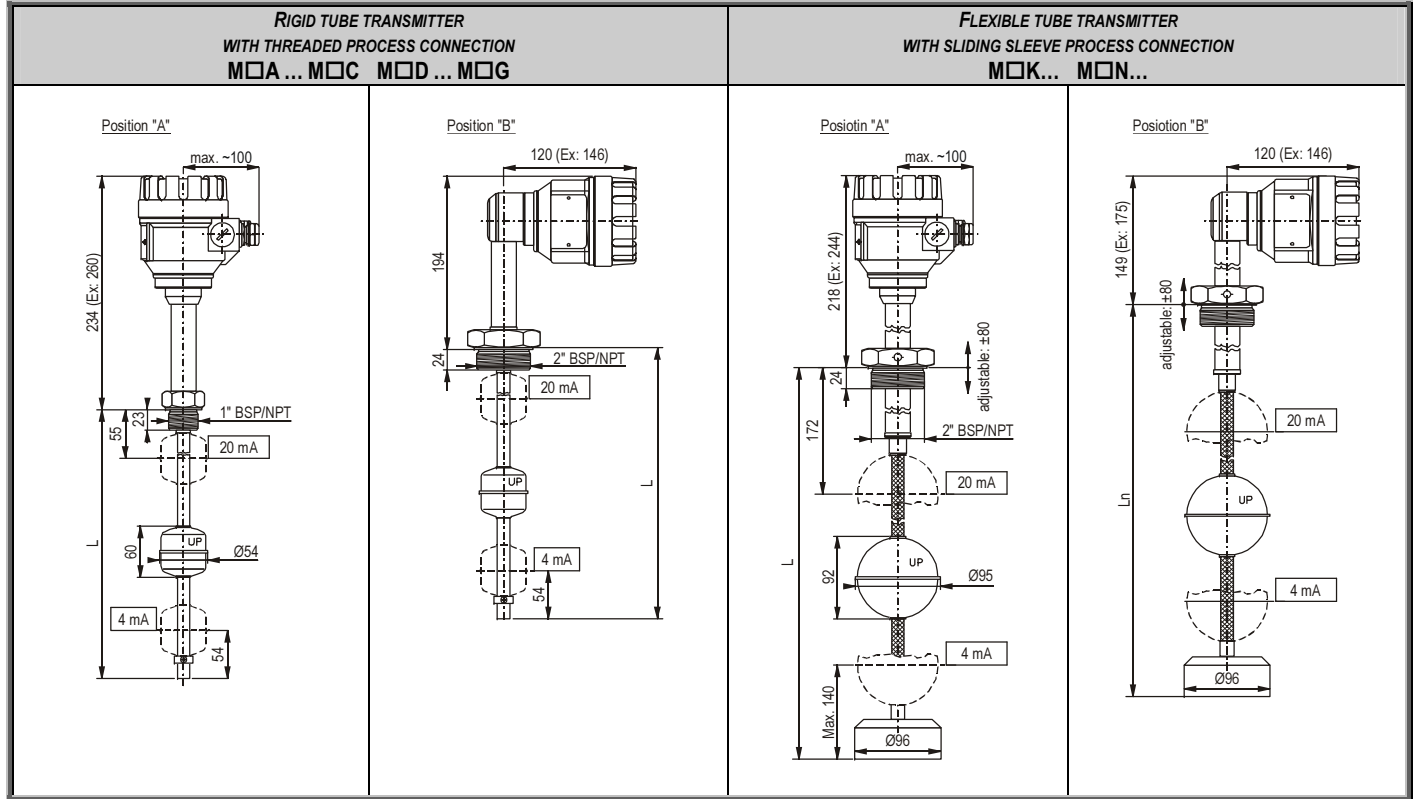

**RIGID TUBE TRANSMITTER
WITHOUT PROCESS CONNECTION
MTU... MBU...**

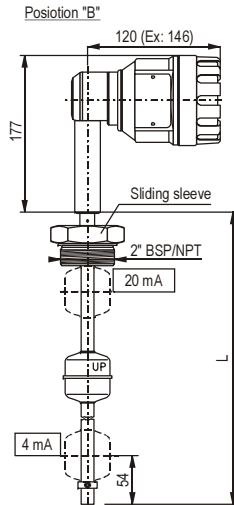
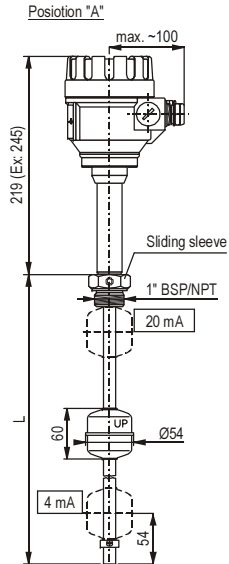

**PLASTIC COATED RIGID TUBE TRANSMITTER
WITHOUT PROCESS CONNECTION
MEU... MGU...**

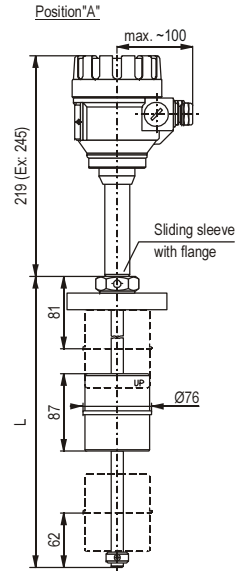

**MINI RIGID TUBE TRANSMITTER
WITH THREADED PROCESS CONNECTION
MM□ ... MC□**

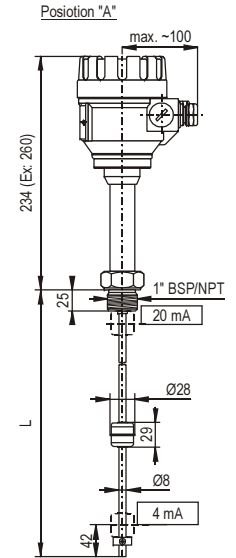

3. TECHNICAL DATA

TYPE	RIGID TUBE VERSION M□A..., M□C..., M□D..., M□G..., MTU..., MBU..., MM□..., MC□...,	FLEXIBLE TUBE VERSION M□K..., M□N...	RIGID PLASTIC COATED VERSION MEU..., MGU...
Measured process values	Level; distance, volume		
Nominal length (L)	0.5 m ... 4.5 m (MM□ and MC□ max. 1.5 m)	2 m ... 15 m	0.5 m ... 3 m
Material of the probe	Stainless steel: DIN 1.4571		PFA coated stainless steel
Max. medium pressure	2.5 MPa (25 bar) (MM□ and MC□ max. 10 bar)	1.6 MPa (16 bar)	0.3 MPa (3 bar)
Medium temperature	-40 °C ... +90 °C, see temperature diagram and table 3.3		
Float diameter / material	∅ 54 x 60 mm cylindrical / 1.4404/Ti ; ∅ 95 mm spherical / 1.4435 ; ∅ 124 mm spherical / 1.4401 ; ∅ 28 x 29 / 1.4404		∅ 76 x 87 mm cylindrical / PVDF/PP
Medium density	with ∅ 54 mm cylindrical 1.4404 float: min. 0.8 g/cm ³ ; with ∅ 54 mm cylindrical Ti float: min. 0.55 g/cm ³ ; with ∅ 95 mm spherical float: min. 0.55 g/cm ³ ; with ∅ 124 mm spherical float: min. 0.4 g/cm ³ ; with ∅ 28 mm cylindrical float: min. 0.7 g/cm ³		
Material of wetted parts	1.4571 (316Ti) stainless steel, float materials are detailed above		PFA + PVDF / PP
Ambient temperature	-40 °C ... +70 °C; see: temperature table in Section 3.5		
Output	Analogue 4...20 mA (limit values: 3.9 and 20.5 mA)		
	Serial comm. HART interface (minimal loop resistance: 250 Ohm)		
	Display SAP 300 graphic display		
Damping time	0 ... 99 s programmable		
Error indication	Current output: 3.8 mA or 22 mA		
Output load	$R_L = (U_i - 12.5V) / 0.02 A$, U_i = power supply voltage		
Power supply	12.5 V ... 36 V DC		
Electrical protection	Class III.		
Ingress protection	IP 67		
Process connection	As per order codes		
Electrical connection	M 20 x1.5 cable gland for cable: ∅ 7 ... ∅13 mm, wire cross section: max. 1.5 mm ²		
Housing	Paint coated aluminium (EN AC 42000) or plastic (VALOX 412) or stainless steel		
Mass	1.7 kg + probe: 0.6 kg/m	2.9 kg + probe: 0.3 kg/m	1.7 kg + probe: 0.7 kg/m

3.1. MEASUREMENT DATA (MSZ EN 60770-1:2011, MSZ EN 61298-1:2009, MSZ EN 61298-3:2009):

TYPE	M□□-□□□-2 M□□-□□□-4 M□□-□□□-6 M□□-□□□-8	M□□-□□□-1 M□□-□□□-3 M□□-□□□-5 M□□-□□□-7 M□□-□□□-9	M□□-□□□-A M□□-□□□-B M□□-□□□-C M□□-□□□-D
Resolution (of the displayed and the transmitted value on the HART line)	1 mm	0.1 mm	
Nonlinearity (of the displayed and the transmitted value on the HART line)	±2 mm or ±0.02% F.S. whichever is greater Under reference conditions	±1 mm or ±0.01% F.S. whichever is greater Under reference conditions	
Hysteresis (under reference conditions)	< ±1 mm	±0.25 mm	
Zero span (in LEVEL measurement mode)	Anywhere within the active range		
Measurement range (reducing)*	Min. range: 200 mm Max. range: see chapter 2.1 (Dimensions)		
Temperature error	0.04 mm / 10 °C (from -25 °C to +50 °C)		
Current output resolution	2 µA		
Current output accuracy	10 µA		
Current output temperature error	200 ppm / °C		

*The detailed accuracy data is only valid under the default factory settings!

3.2. SPECIAL DATA FOR EX CERTIFIED MODELS

TYPE		M □□-5/7 □□-9Ex	M □□-5/7 □□-5Ex M □□-5/7 □□-6Ex M □□-5/7 □□-7Ex M □□-5/7 □□-8Ex	M □□-5/7 □□-CEx M □□-5/7 □□-Dex	M □□-5/7 □□-AEx M □□-5/7 □□-BEx	
		Ex marking	ATEX	Ⓔ II 1 G Ex ia IIB T6...T5 Ga 0.5 ... 15 m	Ⓔ II 1 G Ex ia IIB T6...T5 Ga 0.5 ... 15 m	Ⓔ II 1/2 G Ex d ia IIB T6...T5 Ga/Gb 0.5 ... 10 m
IEC Ex	–		Ex ia IIB T6 Ga 0.5 ... 15 m	Ex d ia IIB T6 Ga 0.5 ... 10 m	Ex d IIB T6 Ga 0.5 ... 10 m	
Electrical connection		–	M 20 x1.5 cable gland	M 20 x1.5 Ex d certified metal cable gland		
Cable diameter		–	Ø 7 ... 13 mm	Ø 9 ... 11 mm		
Ex electrical data		U _{max} = 30 V I _{max} = 140 mA P _{max} = 1 W C _i < 25 nF L _i < 210 µH	U _{max} = 30 V I _{max} = 140 mA P _{max} = 1 W C _i < 15 nF L _i < 200 µH			Ui: 12.5V DC...36V DC

Maximum allowed ambient temperature over medium temperature of +70 °C is according to the diagram

Attention! The M□□-5□□-9Ex type product is with IP68 protection. The cover, cable gland, cable and plug are glued in and cannot be opened!

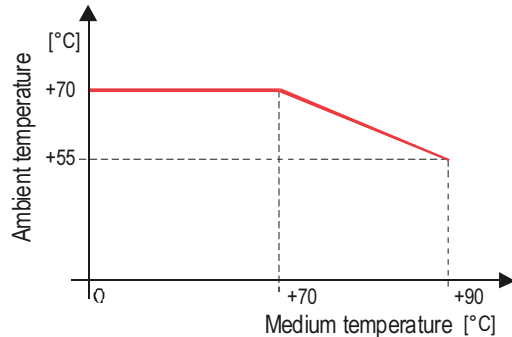

3.3. ACCESSORIES

- Installation and Programming Manual
- Warranty Card
- Declaration of Conformity
- 2 pcs. cable glands (M20x 1.5)
- 1 pc gasket (klingerit oilit) for BSP threads only

For M□K and M□N types only

- 1 pc weight
- 1 pc M 10 nut
- 1 pc M 10 spring washer
- 1 pc M 10 washer
- 1 pc spacer (for float \varnothing 54 mm only)

3.4. SPECIAL CONDITIONS FOR SAFE USE

Aluminium housing of the unit should be connected to the equipotential (grounding) system. For field connections, use cable rated 20°C greater than Maximum Ambient Temperature and seal all threaded entries at enclosure with suitably rated sealing components.

In case of  II 1 G Ex ia IIB T6...T5 Ga protected equipment version with aluminium alloy enclosure, the aluminium-content of enclosure exceeds the limit, thus the equipment must be protected against impact and friction effects and may only be powered by a duly approved and certified Ex ia IIB intrinsically safe loop according to the technical data.

Regarding information on the dimensions of flameproof joints, please contact the Manufacturer.

The risk of electrostatic discharge shall be minimized at installation, especially plastic covered equipment with order code starting with MEU or MGU may be electrostatically charged, therefore:

- Medium to measure must be electrically conductive and with specific resistance not exceeding the value of $10^4 \Omega\text{m}$ even on the most unfavourable places and under the most unfavourable conditions.
- Speed as well as way of filling and emptying should be chosen according to the medium.

For installation in environment with Maximum Ambient Temperature above +55°C refer to Section 3.5. TEMPERATURE CLASSES AND TEMPERATURE LIMITS

3.5. TEMPERATURE CLASSES AND TEMPERATURE LIMITS

LOWER TEMPERATURE LIMITS:

TYPE	EX PROTECTION TYPE		
	ia	d	d ia
MT□ -..., ME□ -...	- 40 °C	- 40 °C	- 40 °C
MB□ -..., MG□ -..., MC□ -..., MM□ -...	- 25 °C	- 25 °C	- 25 °C

MAXIMUM ALLOWED AMBIENT TEMPERATURE OVER MEDIUM TEMPERATURE:

TYPE	TEMPERATURE CODE (TC)	PROCESS TEMPERATURE (PT) MAX	MAXIMUM AMBIENT TEMPERATURE
M□A -..., M□C -..., M□D -..., M□G -..., MEU -..., MGU -..., M□K -..., M□N -...	T6	...+70°C	+70 °C
M□A -..., M□C -..., M□D -..., M□G -..., MEU -..., MGU -...	T6	+70°C ... +80 °C	+55 °C
M□A -..., M□C -..., M□D -..., M□G -..., MEU -..., MGU -...	T5	+80°C ... +90 °C	+55 °C

3.6. MAINTENANCE AND REPAIR

The unit does not require routine maintenance, however the probe may need occasional cleaning to remove surface deposits. Repairs will be performed at Manufacturer's premises. Units returned for repair should be cleaned or disinfected by the customer.

4. INSTALLATION

4.1. MOUNTING

- When choosing the installation place please ensure proper space for later calibrations, verification or maintenance service.
- Waving, vortex or vibration effects have negative influence on the measurement accuracy. To avoid these effects, the mounting placement should be as far as possible from the sources of these disturbing effects for instance from openings of filling or emptying. These effects can be attenuated in applications with rigid tube probes by the use of stilling pipe along the whole probe. Please consult with a NIVELCO distributor!
- To ensure consistent and durable operation the measurement medium should be free of suspended solid materials, which could stick between the float and the probe.
- **The unit should be protected against direct heat radiation.**
- Prior to the installation the mounting dimensions of the unit and the tank as well as the calculations should be checked carefully.
- Prior to the installation a preliminary operation check is suggested.
- If necessary to change the default factory settings the programming should be performed in accordance to the description in the 5th chapter.
- The units are offering a wide variety of process connections according to the available order codes. The tank opening should be fit for the selected level transmitter by means of the insertion hole is bigger than the float diameter. If this is not possible the float has to be removed from the probe and when the unit is mounted into the tank the float can be mounted from inside of the vessel. The “UP” marking on the float ensures that the float is mounted back in the correct position. See the drawing! Prior to finishing the mounting the spacer needed to assemble back between the float and the counterweight.

- In case of MEU and MGU types the probe length can be adjusted. Nevertheless the probe length outside the tank should not be greater than 200 mm.
- **In case of M□K and M□N types with flexible probe are supplied with a counterweight at the end of the probe for straightening the cable probe and fixing it in the right position. The weight and the fastening nut are included with the instrument.**

When lowering down the flexible probe (with the weight at the end) to the bottom of the tank, special care has to be taken to avoid twisting and kinking of the coil. Do not coil the cable less than 60 cm in diameter. Dropping or twitching of the cable probe may damage the unit. To avoid the float to falling down and hitting the weight the float should be placed to the bottom position next to the weight. The weight should not contact with the tank bottom.

The proper straightening of the cable probe can be checked by the analogue output or by the display. If the float is at the bottom position, I_{OUT} should be equal to 4 mA or the displayed measurement value should be 0 mm.

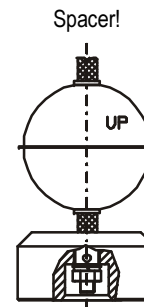

Attention!

In order to avoid damaging the probe, do not put it to torsion when installing or removing the unit. Therefore, special care has to be taken when the process connection is being screwed into or out of the flange. The best is to hold the rigid part of the probe with a suitable tool as long as the process connection is tightened to its place. Sliding sleeve must not be loosened during operation.



Before installation of the unit in potentially explosive environment read Section 3.4. SPECIAL CONDITIONS FOR SAFE USE of this Manual.

4.2. WIRING

This transmitter is designed to operate on 12.5...36 V DC power only (for Ex transmitters: 12.5...30 V DC). The measured voltage on the terminals of the unit should be at least 12.5 V.

Using transmitter with HART a terminal resistance with a minimum value of 250 Ohm should be applied.

The power supply should be interconnected with the unit with twisted, shielded cable that can be pulled through the cable conduit. The cable can be connected to the terminal strip after removing the cover and the display unit.

CAUTION: the enclosure of the transmitter should be grounded. Grounding resistance should be < 2 Ohm. Shielding of the interconnecting cable should be grounded at the control room side. To avoid disturbing noises the interconnecting cable must not be led near to high voltage cables. Especially critical are inductive couplings of AC harmonics against which the protection of shielding is not effective.

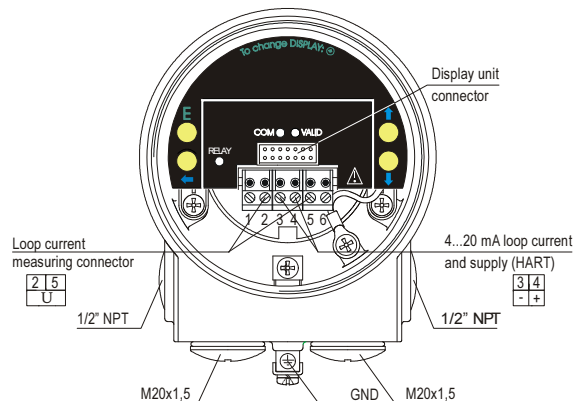

The unit may be damaged by electrostatic discharge (ESD), via its terminal thus used commonly precautions should be applied to avoid electrostatic discharge e.g. touching a properly grounded point before removing the cover of the enclosure.

Possible electrostatic discharge may damage the unit. Thus, the internal electric connection points must not be touched by hand.

4.2.1. Wiring of Ex certified units

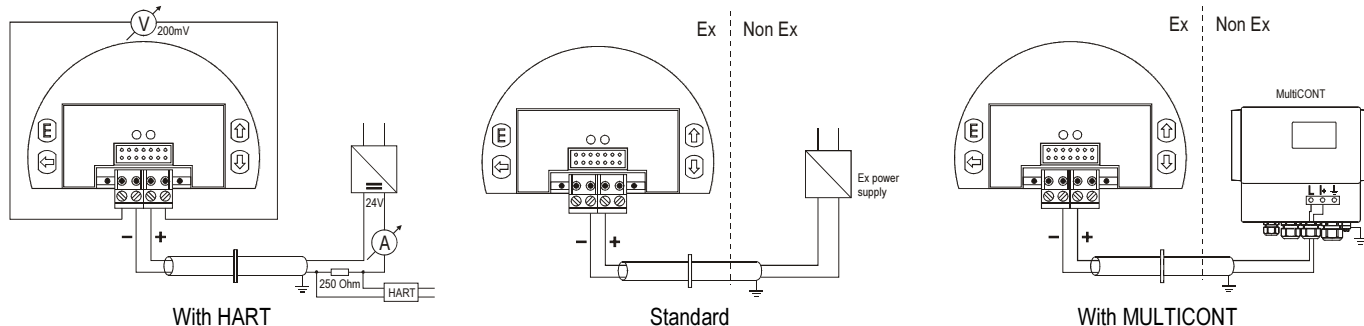

4.3. LOOP CURRENT CHECKING

After removing the cover and the display module the actual loop current can be measured with an accuracy of 0.5 % by connecting a voltmeter (in the range of 200 mV) to the points indicated on the drawing above.



The loop current measuring connectors are designed for checking the proper installation only, they cannot be used as a permanent secondary voltage output. Testing and installation under explosive atmosphere requires approved test equipment and trained personnel!

5. PROGRAMMING

NIVOTRACK transmitters can be programmed by two basic ways.

- **Programming with SAP-300 display unit**, (see chapter 5.2).
- Accessing all the configurable parameters allows full modification of the operation (measurement configuration, zero point offset, output assignments, measurement optimisation, entering dimensions of 11 kind of tanks into parameters, 99-point linearization table).

NIVOTRACK MB□-5□□ and MG□-5□□ types do not include the SAP-300 display unit.

The **NIVOTRACK** transmitters are fully operational without the SAP-300 display unit, the SAP-300 module is needed only for parameter configuration and / or displaying measurement values.

The device measures during the programming procedure in accordance to the previous parameter set. The new, modified parameter set becomes valid after returning into Measurement Mode!

If the transmitter is left in Programming Mode by mistake, it will automatically return to Measurement Mode after 30 minutes and modifications will be unsaved.

FACTORY SETTINGS

The NIVOTRACK M-500/600 type transmitters will be delivered with the following Factory default values:

- ⇒ Measurement mode: level (LEV). Displayed value shows level.
- ⇒ Current output and bargraph on the right side are proportional to the level.
- ⇒ 4 mA and 0% are assigned to minimal level (lowest position of the float).
- ⇒ 20 mA and 100% are assigned to maximal level (highest position of the float).
- ⇒ Error indication by the current output: holds last value of the output.
- ⇒ Level tracking time constant: 0 sec.

The transmitter measures the distance (DIST) from the highest position of the float as primary value. This distance can be processed, displayed in the following units: m, cm, mm, feet, or inch. Since the measurement range of the device is given, the electronics calculate the actual level (LEV). If the mechanical dimensions of the proper mounting position of the device – distance between the lowest position of the float and the bottom of the tank – are also known, then the measured level can be more accurate by this data. The calculated level is used for volume (VOL), or mass (MASS) calculation, and this is the input value of the 99-point linearization process (VMT).

5.1. THE SAP-300 DISPLAY UNIT

5.1.1. THE SAP-300 MODULE

The SAP-300 is a 64x128 dot-matrix LCD display which can be plugged into the transmitter. (Universal – usable in other NIVELCO devices as well – provided that the system software supports SAP-300.)

Warning!

The SAP-300 module is based on LCD technology, so please make sure it is not exposed to permanent heat or direct sunlight, in order to avoid damage of the display unit. If the instrument cannot be protected against direct sunlight or high temperature that is beyond the standard operating temperature range of the SAP-300, please do not leave the SAP display in the instrument.

Displaying with the SAP-300 module

Elements of the display:

1. Primary value (PV), as per BASIC SETUP / PV. MODE.
2. Mode of primary value calculation, as per BASIC SETUP / PV. MODE.
3. Type and value of the initial value for primary value calculation:
 - In case of level measurement: distance
 - In case of volume or mass calculation: level

Trend direction arrows. . Trend direction arrows. The empty triangle shows when the measured value is small, the filled triangle shows large-scale change. The measured value is constant if none of the arrows are shown.

5. Measured value in relation to measurement range (Sensor range) in a bargraph.
6. Indication of primary value simulation. In this case the display and output will show the values of the simulation and not the measured value.
7. Indication of the Volume/Mass calculation table (**V**olume/**M**ass Table - VMT)

During active simulation the critical measurement errors will be displayed to give information to the user.

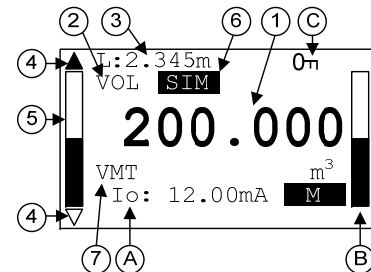

A., Calculated value of the output current. After the dimension, the mode of current output is indicated by inverse inscription:

M Manual mode (see: chapter 5.3.2.1)

H HART address is not 0, so output current has become overwritten to 4mA (see: chapter 5.3.2.1)

E! Analogue transmission reacts to a programmed failure condition if an upper or lower fault current is programmed (see: chapter 5.3.2.4)

B., Output range (4...20mA) indicated in a bargraph.

C., Indication of Menu Lock:

- If key symbol is visible, the unit is protected with a password. When entering the menu, the instrument asks for the correct password.
- If REM message is visible, the instrument is in remote programming mode and the menu cannot be accessed.

Errors occurred during the measurement can be seen at the bottom line of the display.

Information displays:

Press \downarrow button to cycle between the information displays.

1. The general information display (DEV. INFO): overall running time (OV. RUN TIME), run time after power on (RUN TIME), type of interface (INTERFACE), relay (RELAY) and logger (LOGGER) indication.
2. Sensor information display

The informative display switches back to main screen after 30 seconds. By pressing the \uparrow button the user can get back to main screen at any time. Pressing the \ominus button in any of the displays the user can enter to menu. After exiting the menu always the main screen will be shown.

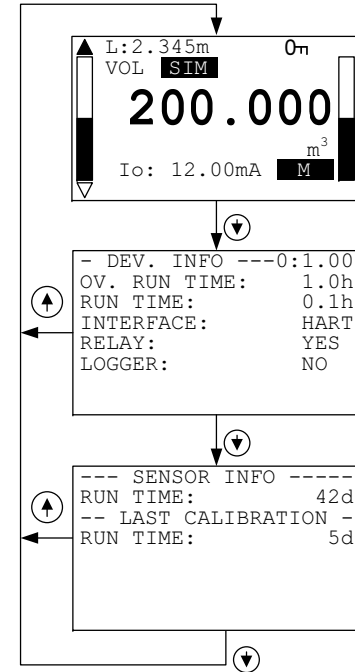

5.2. PROGRAMMING WITH THE SAP-300 DISPLAY UNIT

When entering the menu the instrument makes a copy of the actual parameters, all changes are done to this duplicated parameter set. During programming the instrument keeps measuring and transmitting with the current (and intact) parameter set. After exiting the menu the instrument replaces the original parameters with the new parameter set and will measure according to the new parameters. This means that the change of the parameters does not become immediately effective when pressing the \ominus button! Entering the menu can be done by pressing the \ominus button while exiting the menu can be done by pressing the \odot button.

If the instrument is left in programming mode after 30 mins it will automatically return to measuring mode. If the SAP display is removed during programming the instrument immediately returns to measuring mode.

As programming with SAP-300 (manual programming) and HART (remote mode) programming is not possible at the same time use only one programming method at a time. Measured values can be read out through HART at any time.

5.2.1. Elements of the programming interface

The parameters of the instrument are grouped according to their functions. The programming interface consists of lists, dialog windows, edit windows and report windows.

Lists

Navigation between the lines of a list can be done by pressing \uparrow / \downarrow buttons. Pressing the \ominus button activates a list item. Selected list item is marked with inverse colour. Exit from a list by pressing the \odot button.

Menu list

Menu list is a specialized list. Its characteristic is that upon selecting a list item we directly get into another list, and these lists are opening from each other in different levels. The menu header (1) helps to navigate. Entering the menu can be done by pressing the \ominus button. Navigation between the menu items can be done by pressing the \uparrow / \downarrow buttons. Enter to the selected menu by pressing the \ominus button. The selected list item is marked with inverse colour. Exit from a submenu with \odot button. Pressing the \odot button in the main menu will exit programming mode and the instrument will return to measuring mode.

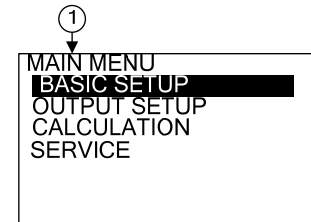

Dialog window

The system sends messages or warnings using dialog windows. These usually can be acknowledged by pressing the \leftarrow button or the user can choose between two options (usually YES or NO) by pressing \leftarrow / \rightarrow buttons. In some cases to correct an error one of the parameters has to be changed.

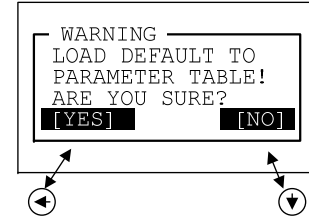

Edit window

An edit window is used for modifying a numeric parameter value. The selected character can be changed using the \uparrow / \downarrow buttons. The cursor can be moved to left, using the \leftarrow button. The direction of the cursor movement through the digits is right to left. Changed value can be validated by pressing the \ominus button. The software checks if the entered value is appropriate, exiting the edit window is only possible after entering a correct value. If the entered value is uninterpretable the software sends an error message in the bottom line (1) of the display. The display gives the same error message, independently of the measured value and the measurement principle.

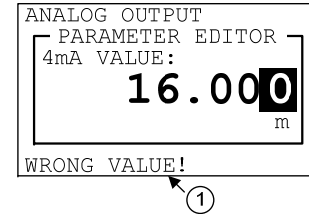

Edit window – button combinations

In the edit window the following button combinations are available:

Recalling the parameters to the state before editing (\leftarrow + \uparrow), pressed for 3 secs);

Recalling default parameters (\leftarrow + \downarrow), pressed for 3 secs);

Inserting (currently) measured value to the edit window (\uparrow + \downarrow), pressed for 3 secs)

Only for certain parameters!

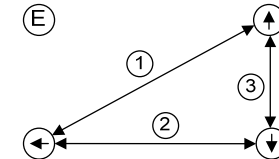

5.2.2. Menu structure

Main menu

BASIC SETUP	Parameter group of the basic measurement parameters
OUTPUT SETUP	Parameter group of the output parameters
CALCULATION	Calculations
SERVICE	Service functions, calibration, test and simulation

5.3. PROGRAMMABLE FEATURES DESCRIPTION

5.3.1. Basic measurement settings

5.3.1.1 Units

Default measuring unit:

Parameter:	P00:c, where a: 0, 1.	Default value:	EU
Menu path:	BASIC SETUP / UNITS/ENGINEERING SYSTEM		
Description:	This should be configured as the first step of the programming. Here you can choose the default unit system: <ul style="list-style-type: none">• EU European unit system• US Anglo-Saxon unit system		

Dimension of the default measuring unit:

Parameter:	P00:b, and P02:b	Default value:	mm, m ³ , t
Menu path:	BASIC SETUP / UNITS/ENGINEERING UNITS		
Description:	The dimension of the unit can be specified in this menu:: <ul style="list-style-type: none">• BASIC UNITS (mm, cm, m, ft, inch)• VOLUME UNITS (m³, l)• MASS UNITS (t, t)		

If the unit is changed, after a warning message the device resets all the parameters.

5.3.1.2 PV mode

Parameter:	P01:b a	Default value:	DIST
Menu path:	BASIC SETUP / PV MODE		
Description:	This mode determines the primary value and the displayed value. It also determines the value which will be proportional to the output current. <ul style="list-style-type: none">• DISTANCE• LEVEL• VOLUME• MASS		

5.3.1.3 Damping time

Parameter:	P20	Default value:	0 sec
Menu path:	BASIC SETUP / DAMPING TIME		
Description:	Damping time is used to damp the unwanted fluctuations of the output and display. If the measured value changes rapidly the new value will settle with 1% accuracy after this set time. (damping according to an exponential function).		

5.3.1.4 Application

Parameter:	P0:a, where a: 0, 1.	Default value:	NORMAL
Menu path:	BASIC SETUP / APPLICATION		
Description:	Application mode, refers to the mounting position of the devices, and affects the function of error indications. <ul style="list-style-type: none">• NORMAL Device sensor is in the tank. Every error indication in normal mode.• BYPASS Device sensor is outside the tank in a measuring tube The „SIGNAL IN N.D.B.“ and „SIGNAL IN F.D.B.“ error indication are inactive.		

5.3.1.5 Installation mode (ONLY USD (UpSide Down) – „Reverse installation position“ devices)

Parameter:	P0:d, ahol d: 0, 1.	Default value:	NORMAL
Menu path:	BASIC SETUP / MOUNTING MODE		
Description:	It reverses the reference points of the level calculation in accordance with the mounting position. <ul style="list-style-type: none">• NORMAL Device housing on top, sensor on bottom (normal position)• UPSIDE DOWN Device housing on bottom, sensor on top (reverse position)		

5.3.2. Analogue Output

5.3.2.1 Output current mode

Parameter:	P12:b, where a: 0, 1.	Default value:	AUTO
Menu path:	OUTPUT SETUP / ANALOG OUTPUT / CURRENT MODE		
Description:	Transmission mode of the current output [AUTO, MANUAL]		
	<ul style="list-style-type: none">• AUTO The output current is calculated from the measured value, output is active.• MANUAL The output current is fixed at a constant (set) value (see 5.3.2.5). In this mode the setting of the error current is irrelevant. The set (current) value overwrites the 4mA output of HART multidrop mode!		

5.3.2.2 Output current value 4mA

Parameter:	P10	Default value:	0 mm
Menu path:	OUTPUT SETUP / ANALOG OUTPUT / 4mA VALUE		
Description:	Measured value assigned to 4mA. The transmitted value is in accordance to the primary value (PV) (P01:a). Assignment can be done that the change in measured value and the change in the output value are the same (normal), or opposite directional (inverse operation). For example: 1m level is 4 mA, 10m level is 20mA, or 1m level is 20mA and 10m level is 4mA.		

5.3.2.3 Output current value 20mA

Parameter:	P11	Default value:	
Menu path:	OUTPUT SETUP / ANALOG OUTPUT / 20mA VALUE		
Description:	Measured value assigned to 20mA. The transmitted value is in accordance to the primary value (PV) (P01:a). Assignment can be done that the change in measured value and the change in the output value are the same (normal), or opposite directional (inverse operation). For example: 1m level is 4 mA, 10m level is 20mA, or 1m level is 20mA and 10m level is 4mA.		
		Active measurement range (mm)	

5.3.2.4 Output current error mode

Parameter:	P12:a, where a: 0, 1, 2	Default value:	HOLD
Menu path:	OUTPUT SETUP / ANALOG OUTPUT / ERROR MODE		
Description:	Error indication by the current output		
	<ul style="list-style-type: none">• HOLD Error indication has no effect on the output current.• 3.8 mA Error indication: the output current gets 3.8mA.• 22mA Error indication: the output current gets 22mA.		
	Warning This error indication is active unless the failure is fixed, or until the failure terminates.		

5.3.2.5 Fixed output current

Parameter:	P08	Default value:	4 mA
Menu path:	OUTPUT SETUP / ANALOG OUTPUT / MANUAL VALUE		
Description:	Parameter for setting the fixed output current		
	Values between 3.8 and 20.5 can be entered. The output current will be set to the entered value and analogue transmission will be suspended (see: 5.3.2.1). This error indication overrides all other error indication.		

5.3.3. Digital Output

5.3.3.1 HART polling address (if there is a HART option in the device)

Parameter:	P19	Default value:	0
Menu path:	OUTPUT SETUP / SERIAL OUTPUT / ADDRESS		
Description:	HART polling address (only HART capable types)		
	The polling address can be set between 0 and 15. For a single instrument the polling address is 0 and the output is 4...20mA (analogue output). If multiple units are used in HART Multidrop mode (max. 15pcs) the polling addresses should differ from 0 (1-15), in this case the output current will be fixed at 4mA.		

5.3.4. Calculations

5.3.4.1 Zero point offset (Distance between the lowest position of the float and the bottom of the tank)

Parameter:	P04	Default value:	0
Menu path:	CALCULATION / LEVEL OFFSET		

Description: This Parameter is used for zero point offset.
In level measurement mode the zero level is meant at the lowest position of the float. Due to the construction of the device, it cannot able to measure the level through the whole height of the tank, because it may not reach the bottom of the tank.
In this Parameter the distance between the lowest position of the float and the bottom of the tank can be entered.
The offset value will be a negative value (the value of the Parameter is always the distance between the lowest position of the float and the zero point offset of the measurement) this negative number should be entered into the Parameter if the measurement range needs to be decreased virtually. The absolute value of this number shall be less than the active measurement range. Factory default Parameter value shall be used if there is no need to use zero point offset. (See: Basic concept of Measurement on the 2nd page).
Wrong configuration of the zero point offset can result negative level display. Negative level is not right or normal. However there is no error indication on negative level display, it cannot be used for 4-20 mA programming or volume / mass calculations.

5.3.4.2 Calculation mode

Parameter: P47:a, where a: 0,1. Default value: 0
Menu path: CALCULATION / V/M CALC. MODE
Description: Calculation of the volume and mass can be performed with two ways:

- TANK FUNCTION/SHAPE – volume and mass calculation with a tank shape formula. Entering this menu point table is automatically OFF.
- V/M TABLE – volume and mass calculation with a table. Entering this menu point table is automatically ON.

5.3.4.3 Tank function / shape

Parameter: P40:a, where a: 0,1, 2, 3, 4. Default value: 0
Menu path: CALCULATION / V/M CALC. MODE / TANK FUNCTION/SHAPE
Description:

- Standing cylindrical tank
- Standing cylindrical tank with conical bottom
- Standing rectangular tank with or without chute
- Lying cylindrical tank
- Spherical tank

5.3.4.4 Tank bottom shape

Parameter: P40:b, where a: 0, 1, 2, 3.

Default value: 0

Menu path: CALCULATION / V/M CALC. MODE / TANK FUNCTION/SHAPE

Description: This menu only appears, if it has an importance on the selected type!

- SHAPE1
- SHAPE2
- SHAPE3
- SHAPE4

5.3.4.5 Tank dimensions

Parameter: P41- P45

Default value: 0

Menu path: CALCULATION / V/M CALC. MODE / TANK FUNCTION/SHAPE

- Description:
- DIM1 (P41)
 - DIM2 (P42)
 - DIM3 (P43)
 - DIM4 (P44)
 - DIM5 (P45)

Standing cylindrical tank with hemispherical bottom $a = 0$

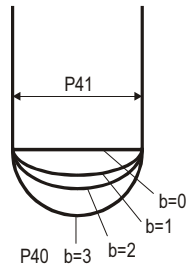

Standing cylindrical tank with conical bottom $a = 1$; $b = 0$

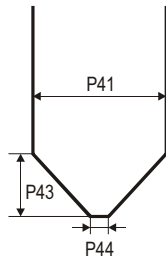

Standing rectangular tank with or without chute $a = 2$; $b = 1$

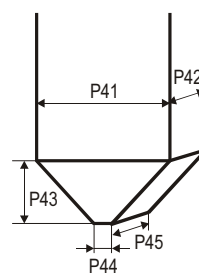

If no chute: P43, P44 and P45 = 0

Lying cylindrical tank $a = 3$

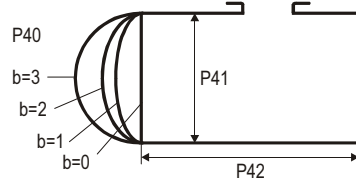

Spherical tank $a = 4$; $b = 0$

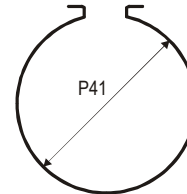

5.3.4.6 Volume and Mass Table (VMT)

Parameter: -

Menu path: CALCULATION / V/M CALC. MODE / V/M TABLE

Description:

- View/Edit table
- Add item
- Delete item

If none of the formulas match perfectly to the characteristics of the needed tank, there is a possibility to use table calculation mode. The device can handle a 99-point table on this purpose and counts values between the neighbouring point pairs with linear interpolation.

The input (left) side of the table contains the level data, the output (right) side contains the volume or mass data.

The first point pair of the table should be 0,0. If a long table wanted to be shortened, 0,0 point pair should be entered into the last item of the table. The device modifies the unused point pairs automatically in the background into 0,0. The status (ON or OFF) of the table is shown on a warning message (1) on the bottom line of the display.

All modifications are done on a temporary table. This temporary table becomes valid after exiting. Modifications during the programming procedure have no effect on the measurement and the transmitting.

Entering the point pairs can be done in arbitrary order, because the device sorts according to ascending order. Both sides of the table have to be strictly monotonic increasing. In case of any error, warning message (see: chapter 6) will appear. When entering again the table inscription indicates the first wrong line.

View table:

In VIEW/EDIT TABLE menu point items of the ordered table can be checked. For moving in the list use the \uparrow and \downarrow buttons, for editing the selected item use the E button. Exiting from the list can be done by pressing the \leftarrow button.

Edit table:

Adding a point pair (ADD ITEM) to the list or pressing E button on an existing item, an edit screen will appear. In this edit screen there are two editing filed. Both editing field work as same as editing a Parameter. Getting from the first field to the second field press the E button. Pressing E button in the second field it will return to the previous menu point. Exiting from the last field, the device performs the ordering of the table.

Delete item

Moving in the list can be done with \uparrow and \downarrow buttons, for deleting an item press the E button on the selected item. Exiting from the list can be done by pressing the \leftarrow button. The table has to contain at least 2 items.

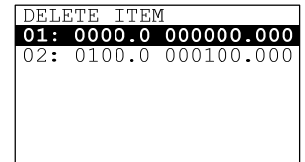
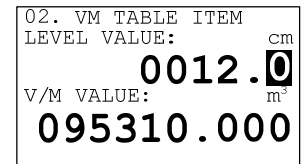
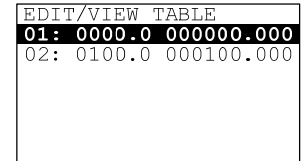
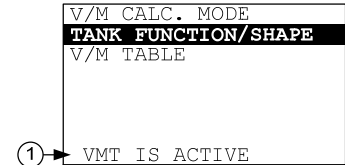

5.3.5. Service functions

5.3.5.1 Security codes

User codes

Menu path: SERVICE / SECURITY / USER LOCK

Description: Setting or unlocking the user security code.

The instrument can be protected against unauthorized programming with a 4 digit PIN (Personal Identification Number) code. If either of the digits differs from 0 the code is active. If zero is specified, then the secret code has been deleted!
In case of Active code, this code is requested at menu entry.

Service code

Menu path: SERVICE / SECURITY / SERVICE LOCK

Description: Setting of the service code.

Only for trained personnel!

5.3.5.2 Current output test

Parameter: P80

Menu path: SERVICE / OUTPUT TEST / ANALOG OUTPUT

Description: Loop current test (mA)

Entering this Parameter the current value which is proportional to the actual measurement value will appear on the display and the output. In loop current test mode, values between 3.9 and 20.5 can be entered. The output current will be set to the entered value. The measured current on the output should be equal to the set value.

In test mode a dialog window warns the user of the fixed output current until the user exits the warning message window.

Exiting can be done by pressing the  button.

5.3.5.3 Distance simulation

This function facilitates the user to be able to check the calculations (tank formula, table), outputs, and the additional processing instruments connected to the output. NIVOTRACK transmitters can perform simulation on the value of a constant or a variable. To start simulation the instrument must return to Measurement mode. In Measurement mode if simulation is in progress, an inverse SIM caption appears on the display.

Simulation mode

Parameter: P84:a, where a: 0,1, 2, 3. Default value: OFF
Menu path: SERVICE / DIST SIMULATION / MODE
Description:

Simulation mode:

OFF

No simulation

FIX VALUE

Value of the simulated distance is set according to the lowest value of the simulation.

TRIANGLE WAVE

Value of the simulated distance changes linearly between the lowest and highest values with an adjustable cycle time.

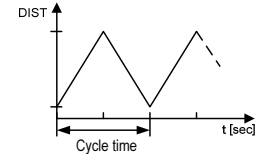

SQUARE WAVE

The simulated value jumps between the lowest and highest values with an adjustable cycle time.

Simulation cycle

Parameter: P85 Default value: 60 sec
Menu path: SERVICE / DIST. SIMULATION / TIME
Description: Cycle time of the simulation

Bottom value of the simulation

Parameter: P86 Default value: 0 mm
Menu path: SERVICE / DIST. SIMULATION / BOTTOM VALUE
Description: Lowest value of the simulation

Upper value of the simulation

Parameter: P87 Default value: Programmed measurement range
Menu path: SERVICE / SIMULATION / UPPER VALUE
Description: Highest value of the simulation

5.3.5.4 Load default values

Menu path: SERVICE / DEFAULTS / LOAD DEFAULT

Description: This command loads all default values of the instrument.

After loading the default values the parameters can freely be changed, the effect of the changes does not affect the measurement until the user exits programming mode and returns to measurement mode. Before loading the defaults the software asks for a confirmation warning the user that all user parameters will be lost!

5.3.5.5 Service distance offset

Parameter: P05

Default value: 0 mm

Menu path: SERVICE / SERVICE DIST OFFSET

Description: There is a possibility to display auxiliary service information on the bottom line of the screen. This information is useful when verifying measurement is performed with a hand-instrument and zero point of this device is not the same as the highest position of the float. In this case a distance should be entered into this Parameter which is the distance between the highest position of the float (which is the zero point of the measurement range) and the zero point of the verifying instrument.

This Parameter has no effect on level measurement or on volume and mass calculation, it only appears on the screen. If the value of this Parameter is not zero, „SDIST=x.xxx” format display appears on the bottom line of the measurement screen.

5.3.5.6 Restart

Menu path: SERVICE / RESTART

Description: Restarts the instrument (Cold boot) (Reloads parameters from the non-volatile memory)

6. ERROR CODES

MESSAGE ON THE SCREEN	ERROR DESCRIPTION	PROCEDURE	CODE
MEMORY ERROR	Memory error in the electronics	Contact the service!	1
NO INPUT SIGNAL	Probe error	Contact the service!	2
EE COM. ERROR	Hardware error (EEPROM communication error)	Contact the service!	3
MATH. OVERLOAD	Display overflow	Check the programming!	4
SIGNAL IN N.D.B.	Probe or calibration error (Signal is in near dead band)	Contact the service!	5
SIGNAL IN F.D.B.	Probe or calibration error (Signal is in far dead band)	Check the mounting specifications.	7
VMT SIZE ERROR	Linearization error: Less than two items are in the table.	Check the content of the VMT! See: 5.3.4.6.	12
VMT INPUT ERROR	Linearization table error: monotonicity error in the input (level) side of the table.	Check the content of the VMT! See: 5.3.4.6.	13
VMT OUTPUT ERROR	Linearization table error: monotonicity error in the output (volume or mass) side of the table.	Check the content of the VMT! See: 5.3.4.6.	14
VMT INPUT OV.RNG.	Linearization table error: The measured level is greater than the highest level of the table's input side.	Check the content of the VMT! See 5.3.4.6. Device performs extrapolation according to the last point pairs!	15
EE CHK ERROR	Parameter checksum error.	Check the programming! For regenerating the checksum, modify a Parameter and return to Measurement mode. If this error still remains, contact the service!	16
INTEGRITY ERROR	Parameter consistency error. (Automatically fixed internal error.) Only WARNING	Check the programming!	17
AC COM. ERROR	Hardware error	Contact the service!	18
CALIBRATION ERROR	Sensor calibration error	Contact the service!	

7. MENU MAP

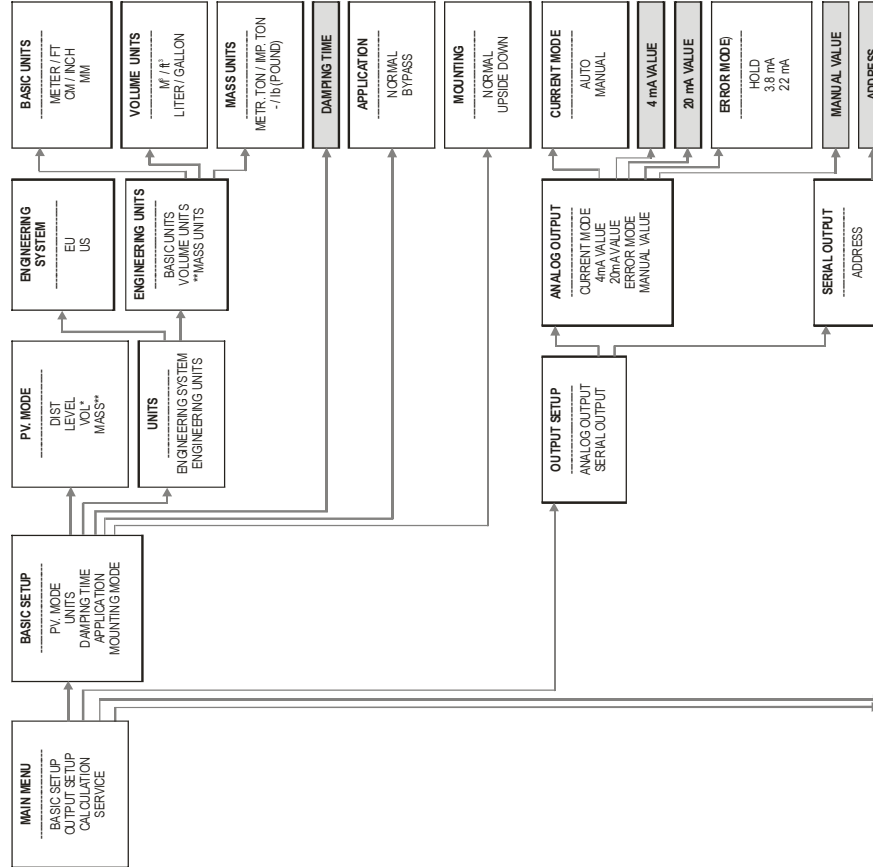

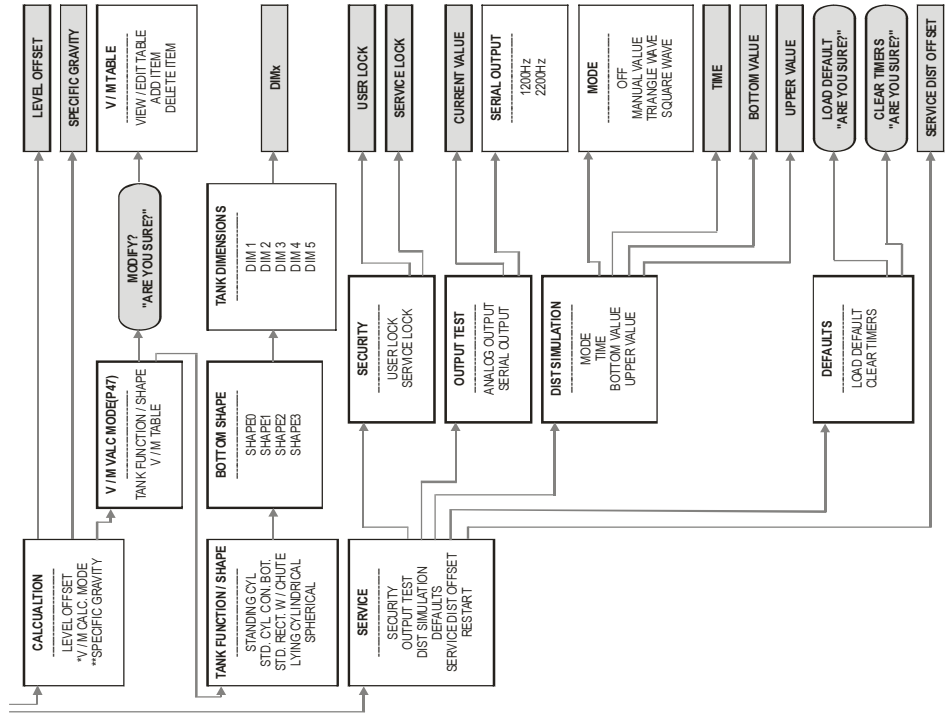

mba5052a0600p_08
August 2017

NIVELCO reserves the right to change technical data without notice!