



X OCS MODEL: HE-X5

Built-In I/O: 4 Digital DC Inputs, 4 Digital DC Outputs, 4 Analog Inputs

1 TECHNICAL SPECIFICATIONS

1.1 General

Required Pwr. (steady state)	270 mA at 12 VDC 150 mA at 24 VDC
Required Pwr. (inrush)	20 A for <1ms at 24 VC DC Switched
Primary Pwr. Range	10-30 VDC
Battery	Non-removable (RTC only)
Clock Accuracy	+/- 8 seconds/month at 25°
Real Time Clock	With Battery
Battery Life	5-10 Yrs Not Replaceable
Relative Humidity	5-95% non-condensing
Operating Temp.	-10° C to +60° C
Storage Temp.	-30° C to +70° C
Weight	10 oz / 271 g
Certifications (CE)	USA: http://www.heapg.com/content/21-certifications Europe: http://www.horner-apg.com/en/support/certifications.aspx

1.2 Display

Display Type	Resistive 4.3" Touchscreen
Resolution	WVGA (480 x 272)
Color	65K Color
Screen Memory	22 MB
User-Program. Screens	1023
Backlight	White LED
Screen Update Rate	User-Configurable w/ in scan time (perceived as instantaneous in many cases)

1.3 Connectivity

Serial	2 (1xRS232, 1x2-wire RS485)
CAN	CAN 125kbps - 1Mbps
Ethernet	1 x 10Mbps/100Mbps
USB	2 (1 x Mini Program) (1 x USB Flash)
microSD	1 x SD, SDHC, SDXC in FAT32 format

1.4 Digital DC Inputs

Inputs per Module	4	
Commons per Module	1	
Input Voltage Range	0 VDC - 24 VDC	
Absolute Max. Voltage	35 VDC Max.	
Input Impedance	10 kΩ	
Input Current	Pos. Logic	Neg. Logic
Min. "On" Current	0.8 mA	-1.6 mA
Max. "Off" Current	0.3 mA	-2.1 mA
Min. "On" Input	8 VDC	
Max. "Off" Input	3 VDC	
OFF to ON Response	2 mS min*	
ON to OFF Response	2 mS min*	
Galvanic Isolation	None	
Logic Polarity	Pos. or Neg. Based on configuration	
I/O Indication	None	
High Speed Counter (HSC)	4 HSC	
HSC Max. Frequency	500 kHz Max.	
Connector Type	3.5 mm Pluggable Cage Clamp	

1.5 Analog Inputs

Number of Channels	4	
Input Signal Range	4-20mA, 0-20 mA DC, 0-10 V DC	
Input Raw Value Range	0-32,000	
Abs. Max. Input Voltage	-0.5 to 12 VDC	
Galvanic Isolation	None	
Input Impedance (clamped at -0.5 to 12 VDC)	mA: 50Ω	V: 500 KΩ
Nominal Resolution	12 Bits	
Conversion Speed	All Channels Once Per OCS Scan	
Analog Max Error at 25° C	1.5% of full scale	

1.6 Digital DC Outputs

Outputs per Module	4
Commons per Module	1
Output Type	Half-Bridge
Absolute Max. Voltage	30 VDC Max.
Output Protection	Short Circuit & Overvoltage
Max. Output Current per Point	0.5 A
Max. Total Current	2 A Total Current
Max. Output Supply	30 VDC
Min. Output Supply	10 VDC
Max. Voltage Drop at Rated Current	0.25 VDC
Min. Load	None
I/O Indication	None
Galvanic Isolation	None
OFF to ON Response	500 nS min*
ON to OFF Response	500 nS min*
PWM Out	500 kHz Max.
Output Characteristics	Current Sourcing (Pos. Logic)

1.7 Control & Logic

Control Lang. Support	Advanced Ladder Logic Full IEC 61131-3 Languages
Logic Program Size & Scan Rate	1 MB, Max. 0.013 mS/K
Online Programming Changes	Supported in Advanced Ladder
Digital Inputs	2048
Digital Outputs	2048
Analog Inputs	512
Analog Outputs	512
Gen. Purpose Registers	8192 words (1024 retentive) 4096 bits (2048 retentive)

* all values updated 1x per scan

2 WIRING & JUMPERS

wiring & jumpers continued...

2.1 - Port Connectors



- 1. Power
- 2. Input Connector
- 3. Output Connector
- 4. CAN Port
- 5. Serial Ports
- 6. DIP Switches
- 7. Ethernet Port
- 8. microSD Slot
- 9. USB A Port
- 10. USB Mini B Port

2.2 - Power Wiring

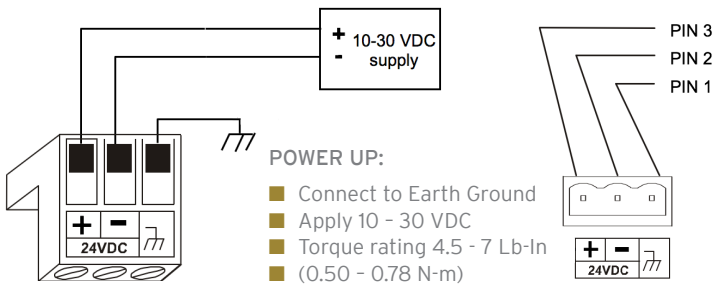

2.3 - Digital Input Wiring

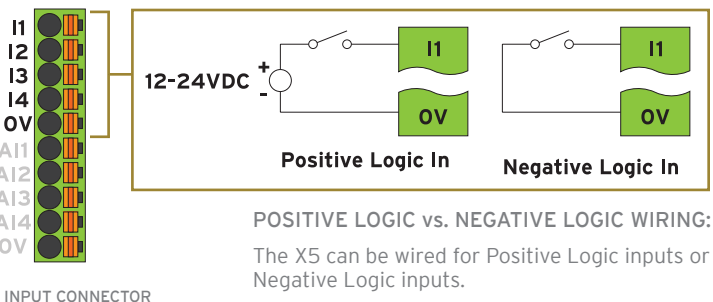

Digital Input Wiring continued...

Digital inputs may be wired in either a Positive Logic or Negative Logic fashion as shown. The setting in the Cscape Hardware Configuration for the Digital Inputs must match the wiring used in order for the correct input states to be registered. No jumper settings are required for X5. When used as a normal input and not for high speed functions, the state of the input is reflected in registers %I1 - %I4.

Digital inputs may alternately be specified for use with High Speed Counter functions, also found in the Hardware Configuration for Digital Inputs. Refer to the X5 User Manual (MAN1039) for full details.

2.4 - Analog Input Wiring

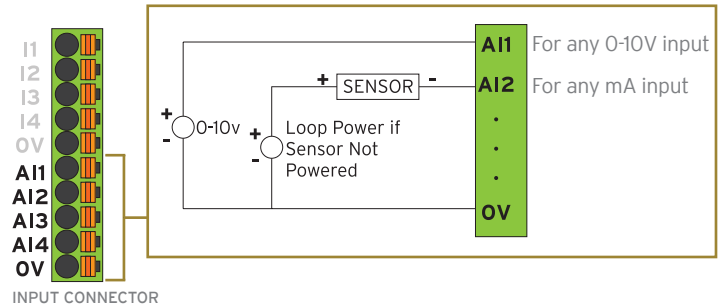

Analog inputs may be configured for 4-20mA, 0-20mA, or 0-10V ranges separately. The configuration is found in the Cscape Hardware Configuration for Analog Inputs. Wiring must match the configuration.

Raw input values for channels 1-4 are found in the registers %AI1, %AI2, %AI3, and %AI4 as Integer-type data with a range from 0 - 32000.

Analog inputs may be filtered digitally with the Filter Constant found in the Cscape Hardware Configuration for Analog Inputs. Valid filter values are 0 - 7 and act according to the following chart.

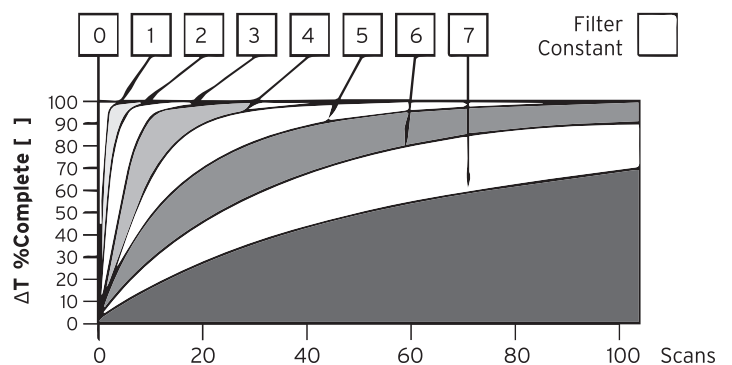

wiring & jumpers continued on next page...

wiring & jumpers continued...

communications continued...

2.5 - Digital Output Wiring

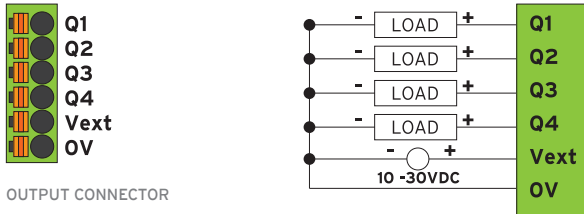

Digital outputs are Positive Logic. If an output is turned on, the voltage supplied at the Vext terminal is applied to that output. When used as normal outputs, the state of the output may be controlled using the registers %Q1, %Q2, %Q3, and %Q4.

The first two digital outputs may alternately be specified for use as Pulse Width Modulation (PWM) or Stepper outputs. The configuration for these functions is found in the Cscape Hardware Configuration for Digital Outputs. Refer to the X5 User Manual (MAN1039) for full details.

3.2 - Serial Communications

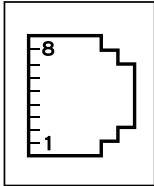

1.8 MJ1 PINS		MJ2 PINS		
PIN	SIGNAL	DIRECTION	SIGNAL	DIRECTION
8	TXD	OUT	-	-
7	RXD	IN	-	-
6	0V	GROUND	0V	GROUND
5	+5V at 60mA	OUT	+5V at 60mA	OUT
4	RTS	OUT	-	-
3	CTS	IN	-	-
2	-	-	RX-/TX-	IN/OUT
1	-	-	RX+/TX+	IN/OUT

MJ1/2 SERIAL PORTS

MJ1: RS-232 w/full handshaking

MJ2: RS-485 half-duplex

Two serial ports on one modular jack

note: refer to connector pinout on product

Two serial ports are provided via the single 8-position modular jack labeled "MJ1/2". MJ1 defaults to one of several methods available to program the controller. It may instead be specified for RS-232 communications with or without hardware handshaking, such as for Modbus Master/Slave, or to communicate to devices such as bar code scanners.

MJ2 may only be used as half-duplex (2-wire) RS-485. The most common use is for Modbus communications, either as a Modbus Master or Modbus Slave, though many other options are also available. Termination for the RS-485 port may be achieved by turning DIP switch 1 to the ON position. Only the two devices on either end of the RS-485 daisy-chain should be terminated.

3 COMMUNICATIONS

3.1 - CAN Communications

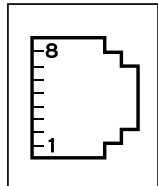

CAN
Modular jack (8posn)
note: refer to connector pinout on product

CAN Pin Assignments		
PIN	SIGNAL	DIRECTION
8	No Connection	-
7	Ground	-
6	Ground	-
5	Ground	-
4	Ground	-
3	Ground	-
2	CAN Data Low	IN/OUT
1	CAN Data High	IN/OUT

The CAN port is provided via the single 8-position modular jack labeled "CAN". It may be used to communicate with other OCS products using Horner's CsCAN protocol. Additionally, remote expansion I/O such as SmartRail, SmartBlock, and SmartStix may be implemented using the CsCAN protocol.

Termination for the CAN port may be achieved by turning DIP switch 2 to the ON position. This should only occur if the X5 is at one end of the CAN daisy-chain or the other. Only the two devices on either end of the CAN daisy-chain should be terminated.

3.3 - Dip Switches

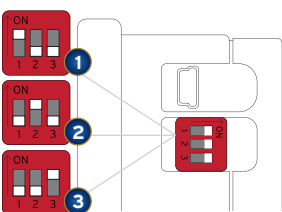

1.9 DIP SWITCHES			
PIN	NAME	FUNCTION	DEFAULT
1	RS-485 Termination	ON = Terminated	OFF
2	CAN Termination	ON = Terminated	OFF
3	Bootload	Always Off	OFF

The DIP switches are used to provide a build-in termination to both the MJ2 port and CAN port if needed. The termination for these ports should only be used if this device is located at either end of the multidrop/daisy-chained RS-485 network or CAN bus.

communications continued...

installation dimensions continued...

3.4 - Ethernet Communications

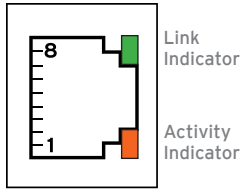

10/100 Ethernet port with automatic MDI-X (crossover detection) is provided via the single 8-position modular jack labeled "LAN". Several features are available for use over Ethernet, such as WebMI, Modbus TCP/IP, Ethernet/IP, SMTP (E-mail), and more.

Ethernet configuration is done via the Cscape Hardware Configuration, though temporary Ethernet configuration may be done through the System Menu directly on the X5.

For more information on Ethernet, available features and protocols, refer to the Ethernet Supplement document (SUP0740).

3.5 - microSD Slot

A MicroSD card may be used for data and alarm logging, historic trending, program loading, firmware updates, and many other features. Supported types of MicroSD cards are SD, SDHC, and SDXC as long as the format of the card file system is FAT32. Card formatting may be done by the controller if no other means are available to do so.

3.6 - USB Ports

The USB Mini B port is provided as one of several ways to program the X5. Drivers for Windows to recognize the controller as a virtual COM port are automatically installed with Cscape software.

The USB A port is provided to be able to use a thumb drive for data and alarm logging, historic trending, firmware updates, and many other purposes. Files may also be transferred between a USB thumb drive and the installed MicroSD card.

4 INSTALLATION DIMENSIONS



5 SAFETY

5.1 - WARNINGS

- To avoid the risk of electric shock or burns, always connect the safety (or earth) ground before making any other connections.
- To reduce the risk of fire, electrical shock, or physical injury, it is strongly recommended to fuse the voltage measurement inputs. Be sure to locate fuses as close to the source as possible.
- Replace fuse with the same type and rating to provide protection against risk of fire and shock hazards.
- In the event of repeated failure, do NOT replace the fuse again as repeated failure indicates a defective condition that will NOT clear by replacing the fuse.
- Only qualified electrical personnel familiar with the construction and operation of this equipment and the hazards involved should install, adjust, operate, or service this equipment. Read and understand this manual and other applicable manuals in their entirety before proceeding. Failure to observe this precaution could result in severe bodily injury or loss of life.

5.2 - FCC COMPLIANCE

This device complies with part 15 of the FCC Rules. Operation is subject to the following two conditions:

- This device may not cause harmful interference
- This device must accept any interference received, including interference that may cause undesired operation

5.3 - PRECAUTIONS

All applicable codes and standards need to be followed in the installation of this product. Adhere to the following safety precautions whenever any type of connection is made to the module:

- Connect the safety (earth) ground on the power connector first before making any other connections.
- When connecting to the electric circuits or pulse-initiating equipment, open their related breakers.
- Do NOT make connection to live power lines.
- Make connections to the module first; then connect to the circuit to be monitored.
- Route power wires in a safe manner in accordance with good practice and local codes.
- Wear proper personal protective equipment including safety glasses and insulated gloves when making connections to power circuits.
- Ensure hands, shoes, and floor are dry before making any connection to a power line.
- Make sure the unit is turned OFF before making connection to terminals.
- Make sure all circuits are de-energized before making connections.
- Before each use, inspect all cables for breaks or cracks in the insulation. Replace immediately if defective.
- Use copper conductors in Field Wiring only, 60/75° C.

6 TECHNICAL SUPPORT

For assistance and manual updates, contact Technical Support at the following locations:

North America
 +1 (317) 916-4274
www.hornerautomation.com
techsppt@heapg.com

Europe
 +353 (21) 4321-266
www.horner-apg.com
technical.support@horner-apg.com